

DECINA

DISCOVER INDULGENCE

DECINA INSET & ISLAND SPA BATHS INSTALLATION & OWNER GUIDE

This guide is designed to provide advice on installing & using your Decina spa bath correctly, to ensure a long lasting installation.



① INTRODUCTION

Thank you for choosing a Decina Spa Bath and supporting an Australian owned company. Your Spa Bath has been manufactured to meet our quality assurance standards and in accordance with the Australian Standards for Spa Baths AS 3861/1991.

This comprehensive installation guide is designed to clarify any necessary information about installing & owning a spa bath.

PRE-INSTALLATION CHECKS _____	1	PUMP & JET OPERATING GUIDE _____	5
BATH INSTALLATION _____	2	TROUBLESHOOTING _____	6
SPA BATH INSTALLATION _____	3	COMMONLY ASKED QUESTIONS _____	6
CONNECTING THE SPA BATH PUMP _____	4	CLEANING THE SPA BATH _____	7
TESTING THE SPA BATH _____	4	WARRANTIES _____	7

IMPORTANT INFORMATION



- ❗ **THIS PRODUCT MUST BE INSTALLED BY A QUALIFIED TRADESMAN.**
- ❗ REMOVE PLASTIC FILM COMPLETELY PRIOR TO INSTALLATION & INSPECT THE ACRYLIC SURFACE OF THE BATH FOR DAMAGE. DAMAGE FOUND AFTER INSTALLATION IS NOT COVERED BY THE MANUFACTURERS WARRANTY CONDITIONS.
- ❗ INSTALLATION OF ANY DECINA PRODUCT SHOULD BE CARRIED OUT BY A QUALIFIED TRADESMAN ONLY.
- ❗ WE RECOMMEND THAT NO 'PRE-FRAMING' WORK BE CARRIED OUT UNTIL THE PRODUCT IS ON-SITE.
- ❗ MODIFICATIONS TO PIPEWORK IS NOT COVERED UNDER WARRANTY, UNLESS PRIOR WRITTEN PRIOR APPROVAL IS RECEIVED FROM DECINA.

PRE-INSTALLATION CHECKS

1. Unpack and check the item is correct & no damage has occurred during transit.
2. If there are any visible defects DO NOT PROCEED WITH THE INSTALLATION and please contact the place of purchase immediately. **ANY CLAIMS FOR DAMAGE WILL NOT BE ACCEPTED AFTER INSTALLATION.**
3. Protect your bath before and during installation, scratches and/or cracks and/or surface damage sustained during or after the installation are not covered by warranty.
4. Installation must be in accordance with building regulations and local authority requirements.

All acrylic baths need to be supported under all rims as well as supporting the full length of the bath.

NOTE DO NOT USE FOAM TO SUPPORT THE BASE OF ANY BATH.

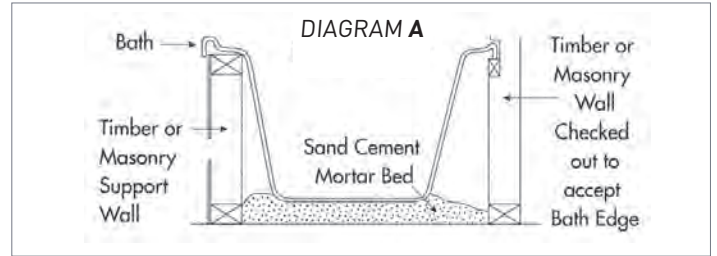

1 SUPPORTING THE BASE - THERE ARE 3 TYPES OF BASE SUPPORT

• BATHS WITH SELF SUPPORTING FEET

Some baths (only those with 5 PVC circles glassed to the base) can be installed on a firm level surface without the need to use a mortar bed. Use a cement based adhesive to glue the base pads to the floor. This must only be done where the support area is completely smooth, clean and level. Spread adhesive liberally over the support floor and base pads and allow for adequate time for it to cure. On a timber floor it is necessary to first lay a fibre cement sheet in accordance with the manufacturer's installation instructions. The bath feet must then be adhered to the sheet with a concrete based adhesive.

• MORTAR BASE

Allow a minimum of 50mm for the mortar bed. Mix the mortar to a dryish consistency to minimise shrinkage and droop. Include a bonding Agent such as BONDCRETE in the mix. It is a requirement of the water authorities that all non-self-supporting baths be supported the full length of the bath base on a mortar mix. When installing an Island bath, the full perimeter also has to be supported by a 'frame' of timber or masonry as per DIAGRAM D.

• BATHS WITH A BASE SUPPORT FRAME

When baths are supplied with steel base (and/or base and rim) support frame, the bath should be slipped into position and the top levelled by adjusting the feet on the frames. All of the adjustable feet of the frame must be in full contact with the floor, so that the base is fully supported.

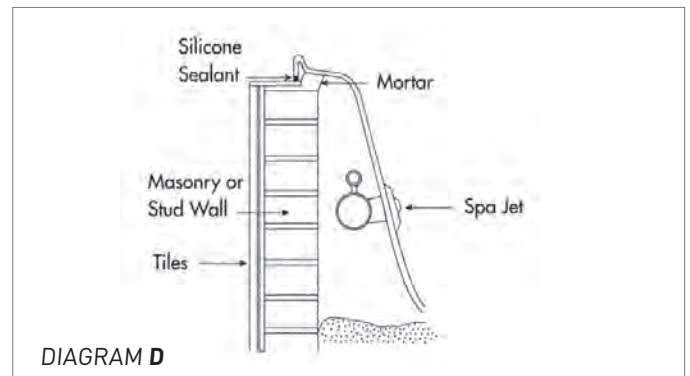

A MORTAR MIX MUST ALSO BE LAID TO FILL THE VOID BETWEEN THE BOTTOM OF THE BATH & THE FLOOR WITHIN THE FRAME PERIMETER IF THE BATH IS GOING TO BE USED AS A SHOWER BATH.

2 DETAIL OF BATH TO WALL

• BATHS WITH A TILE BEAD

Where the bath abuts a wall, it must be set back into the wall as detailed in DIAGRAM B. The wall is checked out to a depth that will accommodate the full round of the tiling bead. A batten is fixed to the wall to support the bottom edge of the bath rim. The front and sides of the bath are to be supported on a dwarf wall constructed in either timber or masonry. The front edge of the bath can overlap the wall as shown in DIAGRAM C or sit on top of the wall to create a ledge as in DIAGRAM D.

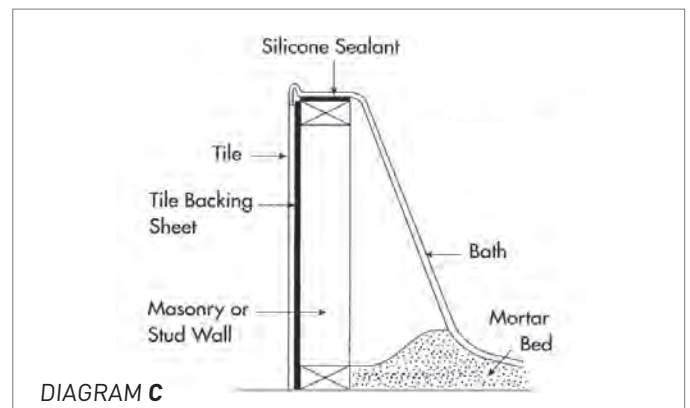
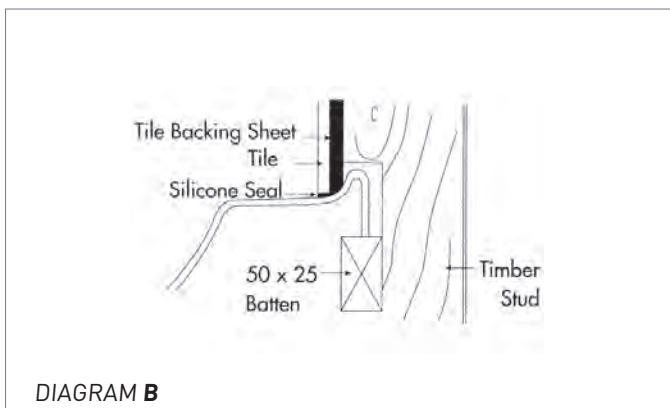

3 SPA BATH INSTALLATION

Once your spa bath is in place it is important to install the spa pump in the desired, optimum position. When determining the Spa Pump Position you must ensure there is adequate ventilation & access for pump maintenance.

3 PUMP INSTALLATION - THERE ARE 2 TYPES OF PUMP INSTALLATION

EXTERNAL SPA PUMP

- You must penetrate the outside wall to accommodate the pipe work to the pump.
- When penetrating the wall, cover the pipe work with duct tape to prevent debris entering the pipework & blocking the jets when the spa pump is turned on.
- The pipe work has been plumbed according to a set height which allows the pump to drain into the bath after use. Support the pump with a timber, masonry or manufactured pump bracket (available from Decina).
- Locate the pump no further than 2 metres from the spa bath and position at the correct height. Keep directional changes to a minimum and use 2 x 45 degree (90 degrees) bends where possible. Use 40mm UPVC Pressure Pipe for plumbing installations.
- For pumps located outside to protect it from the weather ensure it is covered with a spa pump cover available from Decina.

INTERNAL SPA PUMP

- For under hob installation an access panel for ventilation & servicing is required of at least 500mm x 500mm.
- A suitable drain tray (available from Decina) should be installed to avoid water damage to property should any leaks occur from pipe work, connections or normal wear.
- For pumps installed inside a two story house, water proofing is advised.

CORRECT PUMP INSTALLATION

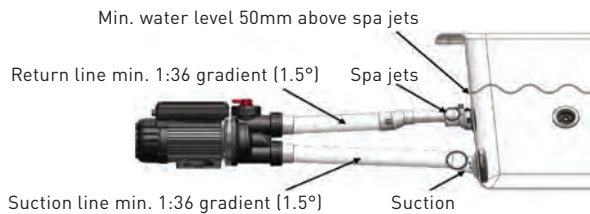

STANDARD INSTALLATION

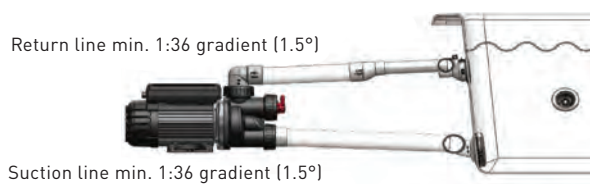

TOP OUTLET INSTALLATION - NOTE the Air Bleed won't activate

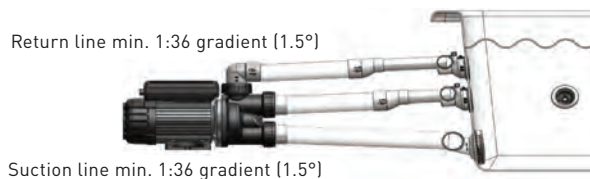

TRIFLO INSTALLATION

INCORRECT PUMP INSTALLATION



PUMP MOUNTED TO LOW - pump can't drain



PUMP MOUNTED TO HIGH - pump can't prime, pump will air lock



INCORRECT PIPEWORK LOOP - pump can't prime, pump will air lock

Once your Spa Pump is in position it is important to connect the spa pump to its control, which will depend on which pump you have.

4 SPA BATH PUMPS & CONTROLS - THERE ARE 3 TYPES OF SPA BATH PUMPS & CONTROLS

• PUMP WITH AN AIR BUTTON CONTROL - AIR TUBE CONNECTION

When the spa bath is installed with an air button (3 metre flexible air tube is supplied). The air tube is attached to the air button (and if applicable fed through a wall penetration) and attached to the air switch nipple. Cut off any excess air tube with a sharp knife and ensure any blockages are cleared in the air tube.

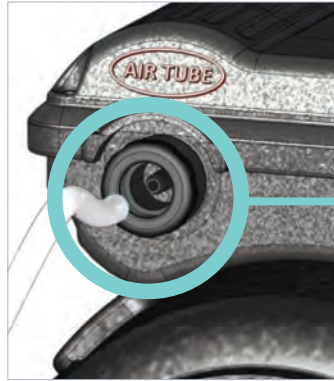

Attach the 3mm flexible air tube (supplied with pump) onto the air switch nipple.

! DO NOT KINK OR WRAP THE AIR TUBE AROUND THE PIPEWORK.

• PUMP WITH A SENSOR TOUCH PAD CONTROL - TOUCH PAD CONNECTION

When the connection from the pump to the touch pad is fitted correctly and the power switched 'ON', there will be a green activation light on the electronic touch pad on the rim of the bath.

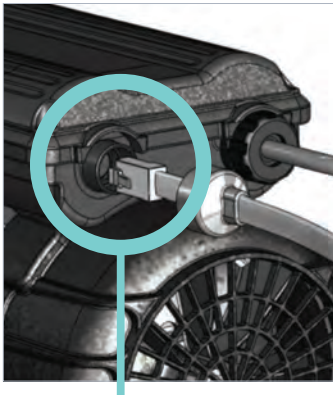

Connect the touch pad cable into the housing, with the alignment shown.

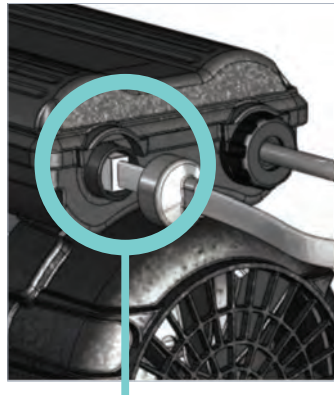

Push the connector into the housing until it 'clicks' into the fixed position.

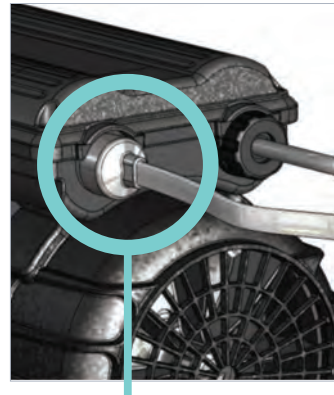

Push the protective rubber cap onto the touch pad cable over the circular housing.

• PUMP WITH A REMOTE SPA KEY PUMP CONTROL - REMOTE WIRELESS CONNECTION













Dolce Vita models are operated with a fully synchronised waterproof remote control, operated by long life batteries.

TESTING THE SPA BATH

1. It is a Decina warranty condition to test your spa bath prior to sheeting & tiling as damage can occur during transit or installation.
2. Before enclosing the bath, ensure that no debris or other material is left in the bath as this could impair the pump.
3. Fill the bath with water at least 50mm above the highest jet, check the pump & all pipe connections for any leaks.
4. Ensure the pump power outlet is switched to the 'ON' position.
5. To check the operation of the pump, air controls & jet flow run the spa for 10-15 minutes.
6. How to start your spa depends on the type of pump you have. Please refer to the Pump & Jet Operating Guide (page 5).

! DO NOT LEAVE WATER IN THE BATH OVERNIGHT.

! NEVER RUN YOUR SPA BATH WITHOUT WATER.

COMPONENTS		OPERATING GUIDE	SANTAI	CONTOUR	DOLCE VITA
Mod Air Button		Press the air button mounted on the rim of the spa bath, the pump will start & purge the air from the system & the spa will start to operate. To stop the spa, press the air button again.	✓	-	-
Touch Pad Control		Press the 'ON/OFF' button on the touch pad, mounted on the rim of the spa bath, the pump will start & purge the air from the system & the spa will start to operate. To stop the spa press the 'ON/OFF' button on the touch pad again. When the pump is on the heating element will come on high, to reduce the temperature press the 'HEATER' button. When the red light disappears the heating element is turned off, press the 'HEATER' button again to switch the heating element back on.	Optional	✓	-
Spa-Key Remote		The red light on the hand held remote indicates the power is on. Press the 'ON/OFF' button on the control, the pump will start & purge water from the system & the spa will start to operate. To stop the spa press the 'ON/OFF' button again. The heating element will come on automatically, to switch it off press the 'HEAT' button. ! NOTE THE 'AIR' & GREY BUTTON ARE NOT APPLICABLE.	-	-	✓
Mod Air Control		Mounted on the rim of the bath, rotate left/right to regulate the airflow to the jet system.	✓	-	-
C-Lenda™ Flush Air Control		Located on the spa bath rim or wall. Rotate half-a-turn left/right to regulate the air flow to the jet system.	-	✓	✓
Mod Suction		Draws water from the spa back to the pump for recirculation. Designed with total safety in mind, this suction has a unique built-in feature that disengages the water pressure within seconds of being activated.	✓	-	-
C-Lenda™ Flush Suction		Draws water from the spa bath back to the pump for recirculation. Designed with total safety in mind, this suction has a unique built-in feature that disengages the water pressure within seconds of being activated.	-	✓	✓
Mod Mini Jet		Designed to provide a concentrated massage in the body and feet areas. This jet is factory set and can't be adjusted.	✓	-	-
C-Lenda™ Flush Mini Jet		Specifically positioned to provide a concentrated massage to the body and feet areas. This jet is factory set and can't be adjusted.	-	✓	✓
C-Lenda™ Flush Adjustable Mini Jet		The mini jet is designed to provide a concentrated massage to the lumbar & feet areas of the body. This mini jet is finger tip adjustable. Adjusting the eyeball of the jet alters the direction of the air & water flow, for a concentrated massage.	-	-	✓
Mod Centro Jet		Designed to circulate air & water flow from the side walls of the spa bath. The Centro Jet is fully adjustable. Rotate the face of the jet half a turn left/right to adjust the water pressure. Adjust the centre of the jet up/down/sideways to alter the direction of the water flow.	✓	-	-
C-Lenda™ Flush Centro Jet		Circulates air & water flow from the side walls of the spa bath. Adjust the eyeball of the jet up/down/sideways to alter the direction of the water flow.	-	✓	-
C-Lenda™ Flush Maxi Jet		High performance Maxi jets deliver increased air & water flow from the side walls of the spa bath. This jet is fully adjustable, by rotating the centre of the jet you can alter the water direction & flow.	-	-	✓

PROBLEM	POTENTIAL CAUSE	POTENTIAL REMEDY
WATER LEAKING FROM AROUND THE JET BODY	<ul style="list-style-type: none"> - A misalignment between the jet body, locking nut and the bath wall - A broken seal on the silicone due to movement of the pipe 	- Refer to the SPA PUMP INSTALLATION section (refer to page 3) or contact Decina
WATER LEAKING FROM THE WATER PIPES LEADING INTO THE JET BODIES AND OTHER CONNECTIONS	<ul style="list-style-type: none"> - Not enough glue applied to the water pipe and inside the jet body - Pipe not inserted correctly - Broken glue seal due to movement of pipe i.e. mishandling 	- Refer to the SPA PUMP INSTALLATION section (refer to page 3) or contact Decina
WATER LEAKING FROM THE SPA JET BODY	- A faulty jet body through manufacturing or mishandling	- Refer to the SPA PUMP INSTALLATION section (refer to page 3) or contact Decina
JET FACE IS 'POPPING OUT' FROM THE ACRYLIC SHELL OF THE BATH/SPA BATH	- Faulty jet face/body locking mechanism	- Refer to the SPA PUMP INSTALLATION section (refer to page 3) or contact Decina
WATER IS LEAKING FROM THE WATER PIPE	<ul style="list-style-type: none"> - Water pipe overheated or stretched - Water pipe is cracked 	- Refer to the SPA PUMP INSTALLATION section (refer to page 3) or contact Decina
WATER IS LEAKING NEAR THE SPA BATH PUMP	- Misaligned barrel unions or O-rings (supplied) not fitted	- Plumber/installer should be able to fix
PUMP STARTS BUT NO WATER IS PUMPING FROM THE JETS	<ul style="list-style-type: none"> - Insufficient water in bath - Pump installed incorrectly i.e. too high - Unattached air line - A split in the air line 	<ul style="list-style-type: none"> - Water to be completely covering the jets (refer to page 4) - Lower pump - Installer can attempt to hook air-line with a wire coat hanger and reattach to spigot under power button - Test by blowing into air line to see if that starts the pump, if so lower pump
PUMP WON'T TURN ON (MANUAL)	<ul style="list-style-type: none"> - Pump power connection is not switched on - Air tube not connected to the pump correctly 	<ul style="list-style-type: none"> - Check the power connection is switched to the ON position - Check air line is attached correctly at both ends & is not damaged or blocked (refer to page 4) if there is no improvement contact Decina
TOUCH-PAD NOT WORKING OR WORKING INTERMITTENTLY	- Check the touch pad is correctly connected & the cable is not damaged	<ul style="list-style-type: none"> - Check the power connection & the pump is plugged in correctly - Replace the cable (RJ45 cable) or touch pad, contact Decina
THE PUMP IS NOT TURNING OFF (ELECTRONIC)	- Faulty touch-pad or cable	- Replace the cable (RJ45 cable) or touch pad, contact Decina

COMMONLY ASKED QUESTIONS

Q: ARE SPA BATHS SAFE?

A: Decina spa baths comply to stringent Australian safety requirements and have multiple, automatic, built-in safety features that cut-off power for any jet blockages or if no water is present.

Q: HOW MUCH WATER WILL MY BATH / SPA BATH USE?

A: Decina products are economical to run and use minimal water. You must fill your spa bath at least 50mm above the highest spa bath jets to ensure there is enough water for the spa pump to operate.

Q: WHAT ARE THE ELECTRICAL REQUIREMENTS FOR RUNNING A SPA BATH?

A: Decina spa baths run on a 10 amp standard power supply and are whisper quiet generating only 65 decibels while in use.

Q: WHAT BATH/SPA PRODUCTS CAN I ENJOY IN MY SPA BATH?

A: You can use water soluble bath products designed for spa baths or a small amount of high quality bubble bath. Avoid using bath oils or oily products (hair conditioners, soaps and emollient skin treatments), as they can cause a build-up in the pipes, that dirt and grime sticks to, making cleaning difficult.

7 CLEANING THE SPA BATH

• WEEKLY CLEAN

You can clean your spa bath weekly with a general wipe, warm soapy water or a mild bathroom spray, to maintain the acrylic surface and chrome jets.

• 3 MONTHLY CLEAN

A quarterly maintenance clean should be carried out by filling your spa bath with water and adding NapiSan, bicarb soda or Spa Gene and running the spa bath for 30 minutes, to remove any build-up and soap scum from your pipe-work, jet fittings and pump.

WARRANTIES



ACRYLIC
INSET/ISLAND BATHS
(excludes spa bath shells)



SPA BATH SHELLS
& PIPEWORK*



SPA BATH PUMPS,
JETS & FITTINGS*



SPA BATH OVERFLOWS,
WASTES & HEADRESTS*

These extended warranties only apply to faults or defects which have arisen solely from faulty materials or workmanship in the Products and does not apply to other defects which may have arisen as a result of, without limitation, the following: accidental damage, installation damage, installation that does not follow the companies recommendations, abuse, misuse, maltreatment, abnormal stress or strain, harsh or adverse weather conditions, including excessive water temperature, or neglect of any kind of the Products. Any changes to the Product as supplied. Repairs of the Products other than by a Decina accredited or licensed service agent or technician are not covered. This extended warranty for the Products commences from date of purchase.

In addition to this extended warranty, certain legislation (including the ACL) may give you certain rights which cannot be excluded, restricted or modified, this extended warranty must be read subject to such legislation and nothing in this warranty has the effect of excluding, restricting or modifying those rights.

To make a warranty claim, please visit decina.com.au/warranty-claim/ or email services@decina.com.au and attach the following:

- Proof of purchase (original invoice from the supplier)
- Details of the warranty claim (including the installation, installers and head contractors details, the date the issue was found)
- Your contact details

If the Product has not been installed, please contact Decina for their authorised agent to inspect the Product. If the claim is accepted the Product can be returned with the Proof of Purchase (POP), to the place of purchase or Decina will arrange a collection and replacement. Note: The extended warranty only applies to the original owner and is not transferable.

Should any warranty claim be made and attended to by a Decina authorised Service Agent and that in the opinion of the Service Agent or Decina, the problem was from faulty installation or use of the Products in conjunction with Products of another manufacturer or from some other cause other than a manufacturing defect of the goods for which Decina is responsible. Decina Bathroomware Pty Ltd reserves the right to charge a service fee for each service staff attending the premises where Products have been installed.

As part of Decina's commitment to continuous improvement, Decina reserves the right to make changes to its Product at any time.

Our goods come with guarantees that cannot be excluded in the Australian Consumer Law. You are entitled to a replacement or refund for a major failure and for compensation for any other reasonably foreseeable loss or damage. You are also entitled to have goods repaired or replaced if the goods fail to be of acceptable quality and the failure does not amount to a major failure.

! THE WARRANTIES ABOVE APPLY ONLY TO THIS INSTALLATION GUIDE. OTHER PRODUCTS MANUFACTURED BY DECINA MAY HAVE DIFFERENT WARRANTY ARRANGEMENTS.

DECINA
DISCOVER INDULGENCE

DECINA.COM.AU 1300 DECINA   

*Warranty T&Cs apply, visit decina.com.au Decina reserves the right to change specifications without notice. Due to manufacturing tolerances dimensions may vary +/- 5mm. We recommend installation does not start until after delivery. Please confirm all particulars prior to purchase, call 1300 DECINA or visit decina.com.au

Copyright Decina Bathroomware Pty Ltd ABN: 39 845 084 033