

# Koko®

## WALL-HUNG TOILET SUITES

**K2376**



Rimless



Soft Close

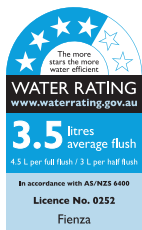

Gloss White · K2376W-PS

Matte White · K2376MW-PS

Matte Black · K2376MB-PS

- Rimless, hygienic flush
- Concealed pan for easy cleaning
- UF quick release, soft close seat
- Stainless steel hinges
- Available as P-Trap only
- Wall mounting screws included
- **WELS 4 Star rated, 4.5L/3L (3.3L average flush) when used with R&T cistern**



**CHECK GOODS THOROUGHLY BEFORE INSTALLATION**

Installation of received goods that are damaged, warped or faulty will void warranty. Ensure all items meet your plumbing requirements.



Gloss White



Matte White



Matte Black

### Installation Notes

Please consult the installation guide supplied with your chosen in-wall cistern to install this toilet suite.

The technical drawings below provide relevant dimensions for installation.

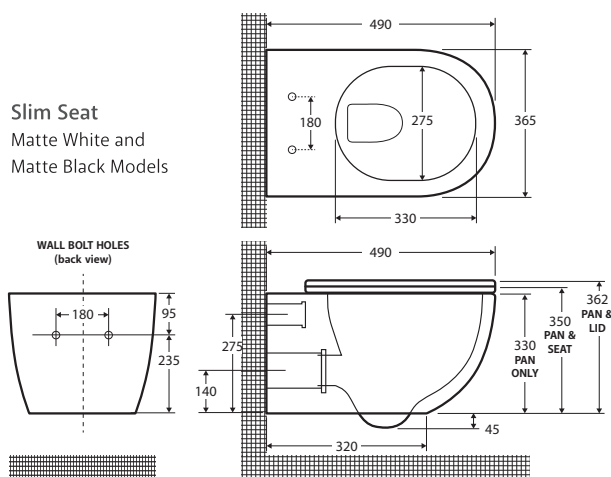
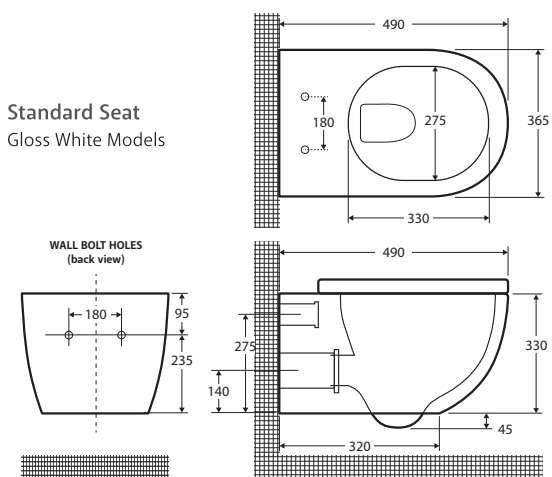

**IMPORTANT:**

When marking inlet positions, please note that dimensions provided are from finished floor and wall levels (e.g. finished tile surfaces).







All installations should be carried out by a qualified tradesman in compliance with the National Plumbing & Drainage Code and any State or Local Authority Regulations, in accordance with AS/NZS 3500 series of standards and AS/NZA 6400. All measurements are in millimetres and are subject to change without notice. For ceramic products, please allow +/- 10 mm tolerance for manufacturing variance. Please refer to [fienza.com.au](http://fienza.com.au) for the latest product specification.

## Wall Mounting Instructions

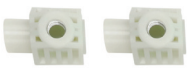
COMPONENTS			
			
2 x Mounting Rods	2 x Screw Fittings	1 x Hex Key	

  

PRE-FITTED COMPONENTS			
			
2 x Mounting Plugs	2 x Mounting Plug Screws	2 x Washers	1 x Plug Screw Key

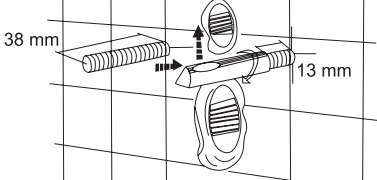

- Screw the mounting rod onto the fixing screw protruding from the wall. Ensure that the notches in the rods are facing up. Line up the fixings to the seat slots and click into place.

- Move the pan into place sliding it over the mounting rod and flush with the wall. Plugs come pre-fitted to the pan.

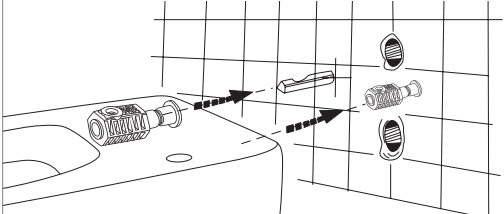

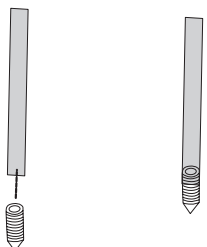
- Place the plastic pipes over the two screw fittings.

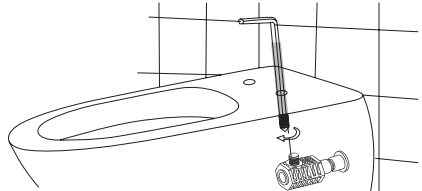
- Insert the hex key into the other end of the plastic pipe and screw the fitting into place as shown above. Remove the plastic pipe and hex key.

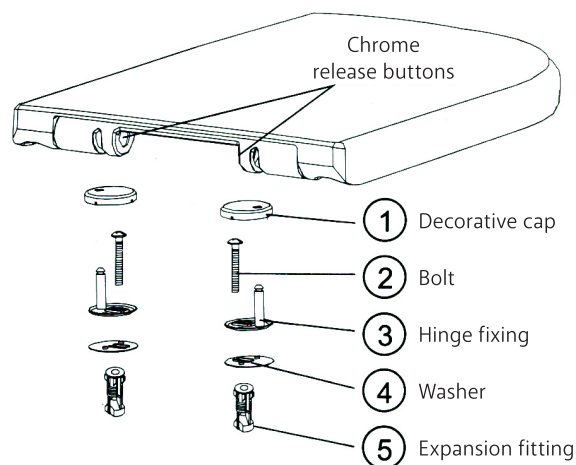

## Standard Seat Installation

- Open the box and check all the components.
- Insert the expansion fittings (5) into the seat bolt holes in the WC.
- Assemble washers (4), hinge fixings (3) and bolts (2) as shown in the diagram. Leave loosely attached.
- Align the hinge housing of the seat with the hinge fixings and adjust the seat to desired position.
- Remove the seat by depressing the chrome release buttons and lifting upwards.
- Tighten the bolts with a Phillips head screwdriver ensuring that the expansion fittings are secure. Put the decorative cap in the position then attach the seat on the hinges.



All installations should be carried out by a qualified tradesman in compliance with the National Plumbing & Drainage Code and any State or Local Authority Regulations, in accordance with AS/NZS 3500 series of standards and AS/NZA 6400. All measurements are in millimetres and are subject to change without notice. For ceramic products, please allow +/- 10 mm tolerance for manufacturing variance. Please refer to [fienza.com.au](http://fienza.com.au) for the latest product specification.

## Slim Seat Installation

1. Insert the hinge set into the holes on the pan.



2. Line up the fixings to the slots on the seat and click seat into place.



3. Adjust the position of the seat to suit the pan.



4. Push the quick release button and lift the seat straight up to remove.



5. Tighten the screws.



6. Fix the hinge covers over the hinges.



7. Replace the seat.



All installations should be carried out by a qualified tradesman in compliance with the National Plumbing & Drainage Code and any State or Local Authority Regulations, in accordance with AS/NZS 3500 series of standards and AS/NZA 6400. All measurements are in millimetres and are subject to change without notice. For ceramic products, please allow +/- 10 mm tolerance for manufacturing variance. Please refer to [fienza.com.au](http://fienza.com.au) for the latest product specification.

## Warranties

### Residential Warranty Periods

Applies to domestic uses and applications of Fienza® products, such as private dwellings and retirement villages.

### Commercial Warranty Periods

Applies to commercial uses and applications of Fienza® products, including, but not limited to: commercial food premises such as restaurants; commercial accommodation such as hotels; hospitals and healthcare facilities; public amenities; and industrial, laboratory and manufacturing facilities.

TOILETS*		*Excludes parts subject to wear and tear such as rubber seals.
Range / Component	Residential	Commercial
Vitreous China	5 years replacement parts or product, 1 year labour	3 years replacement parts or product, 1 year labour
R&T Cisterns (Tanks & Frames)	5 years replacement parts or product, 1 year labour	5 years replacement parts or product, 1 year labour
R&T Cisterns (Valves)	3 years replacement parts or product, 1 year labour	1 year replacement parts or product, 1 year labour
R&T Flush Button Plates	2 years replacement parts or product	1 year replacement parts or product
Geberit Cisterns (Tanks & Frames)	15 years replacement parts or product	15 years replacement parts or product
Geberit Cisterns (Valves)	3 years replacement parts or product, 1 year labour	3 years replacement parts or product, 1 year labour
Geberit Flush Button Plates	3 years replacement parts or product	3 years replacement parts or product
Seats, Accessories & Spare Parts	1 year replacement parts or product	1 year replacement parts or product

### Warranty Conditions

- Installation has been carried out by a licensed tradesperson in accordance with all applicable Building, Plumbing and Electrical codes, and Federal, State, or Local Government Regulations in accordance with AS/NZS 3500 Plumbing & Drainage, AS/NZS 6400:2016 Water Efficient Products, and AS/NZS 3000:2007 Electrical standards for any installations to which these standards apply.
- All maintenance and adjustments to the product after the installation have been carried out by a licensed tradesperson.
- All care and cleaning instructions have been adhered to as prescribed.
- All goods of substandard quality manufacture (excluding imperfections permitted within AS1976 - Vitreous China used in Sanitary Applications) will be credited or replaced by Fienza when advised within the warranty period, subject to prior inspection and agreement.
- Proof of purchase is required for warranty claims.

### Warranty Limitations

To the extent permitted under the Trade Practices Act and other relevant legislation, Fienza's liability is limited to:

- The cost of replacing the goods, or
- The cost of obtaining equivalent goods, or
- The cost of having the goods repaired.
- Fienza is not responsible for any lack of operation or performance of goods (or any loss or damage) where goods are used or adapted for use with other goods not supplied by Fienza.
- It is the responsibility of the customer and installer before installation to ensure that all components are correct and free of obvious visible faults.
- Fienza is not responsible for the labour and rectification costs incurred in the above circumstance.

### Conditions for On-Site Warranty Service Calls

Fienza will charge a service fee for each visit to an installation by its technician where it is determined that the fault is due to poorly executed or unlicensed installation work or where the product is not a genuine Fienza product or where the product is outside the warranty period. This may be paid in advance by credit card over the phone to a Fienza technician attending the site and will be refunded if the Fienza product is found to be at fault.

#### For warranty support, please contact Fienza

2 Bailey Court, Brendale QLD 4500  
 PO Box 5381, Brendale QLD 4500  
**P** 07 3490 6700 **F** 07 3490 6719  
**E** [help@fienza.com.au](mailto:help@fienza.com.au) ABN 76 136 411 311

All installations should be carried out by a qualified tradesman in compliance with the National Plumbing & Drainage Code and any State or Local Authority Regulations, in accordance with AS/NZS 3500 series of standards and AS/NZA 6400. All measurements are in millimetres and are subject to change without notice. For ceramic products, please allow +/- 10 mm tolerance for manufacturing variance. Please refer to [fienza.com.au](http://fienza.com.au) for the latest product specification.